



technical specifications LR7/90

general

- RBN401 pro-ribbon HF driver with exceptional intelligibility and “throw”
- Patented constant horizontal dispersion up to beyond 20 kHz
- Left/Right system from single cabinet with Androgyn™ flying system
- SIS™ pre-wired for very high damping and further reduced distortion (with ALC)
- Ultra-compact enclosure provides versatile array deployment
- All Neodymium drivers for excellent performance-to-weight ratio



description

The LR7 is a passive 2-way “micro-sized” line-array sound system, to be used as vertical array, either in stacked or flown configuration, for both portable and permanent installations.

Loaded with the RBN401 pro-ribbon driver on a “Morpher” lens (up to 94% frontal radiation), the system offers a very high throw-efficiency and projection control up to directly under the array, due to the pro-ribbon's all-natural cylindrical (Isophasic) wavefront.

Its transient response and unusual high peak power handling (800W @ 200ms) cater for a perfect intelligibility from the lowest to the highest SPL with a 1:15 dynamic range, while offering maximum “gain-before-feedback”.

The system features a consistent, patented horizontal dispersion with seamless coverage, available in 90° and 120° configuration.

The micro-compact size, combined with the weight-saving all-Neodymium drivers, makes the system very easy to handle in a wide variety of configurations; As stacked or flown line-array, or with 3 or 5 modules as “speaker-on-a-stick”; In applications where extended bass response is required, the LR7 can be combined with the LR7B line-array bass module and/or a stacked subwoofer system.

The Androgyn™ flying hardware enables an acoustically-symmetric left / right system, with the asymmetric LR7 module.

The LR7 is driven by the Sentinel amplified loudspeaker controller, optimising the system's response by LR7-specific drive processing and feedback for each array configuration, including presets for phase-matched low-frequency extensions.

The Signal Integrity Sensing™ pre-wiring ensures dynamic cable/connector compensation between the LR7 and ALC; This offers a 1:1, undistorted natural sound reproduction, regardless of cable length and amplifier impedance load (system damping factor 10.000).

Typical (short to medium throw) applications for the LR7 include as compact main system for performing arts theatre, A/V or corporate events where with exceptional sound reproduction is required, with minimal sightline obstruction.

technical specifications LR7/90

dimensional drawing

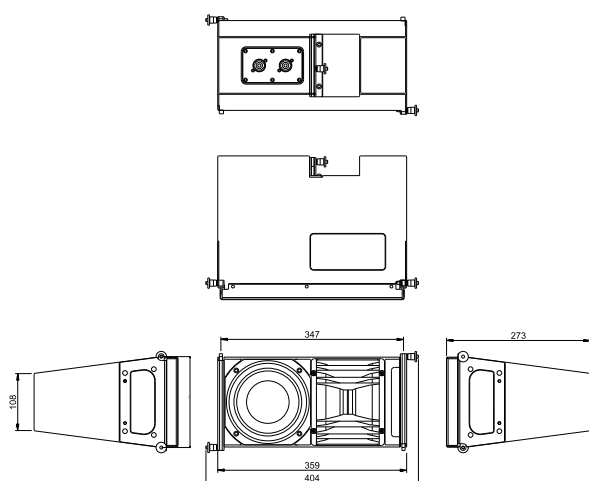

technical specifications

Frequency response	74 Hz - 20.000 Hz (+/- 3dB)
	53 Hz - (+/- 10dB)
Sensitivity nominal	102 dB (200 Hz - 10 kHz)
Nominal impedance	16 ohms
Recommended drive	Sentinel3 min., max. 6 pcs. per channel (2.7 ohms)
Nominal SPL peak	126 dB (Sentinel3 200 Hz - 10 kHz)
	131 dB (Sentinel10 200 Hz - 10 kHz)
Dispersion H x V (array)	90° x depending on array length
Dispersion H x V (single)	90° x 15° (line-source)

physical specifications

System	2-way, full-range	
Filtering	passive	
Driver LF	1x AND6.5/16 6.5", vented	
Driver HF	1x RBN401 4" pro-ribbon driver	
Connectors	2x Speakon NL4 input / link	
Physical dimensions	mm	inches
Height	173 / 108	6.9 / 4.3
Width	359	14.1
Depth	273	10.7
Weight (approx.)	8 kg	17,6lb
Warranty	6 years limited	

A: Alcons Audio B.V
De Corantijn 69
1689 AN Zwaag
The Netherlands

E: info@alconsaudio.com
W: www.alconsaudio.com
T: +31 (0) 229 28 30 90
F: +31 (0) 229 28 30 99